

# ADD S

Francesco Rota | 2016



# ADD S

Francesco Rota | 2016

Documents, books and objects. Memories and visions of the future. Any period of design can find a space in the ADD system storage units. In line with the inventive creativity of seating, metal units can be arranged in a versatile way, combined with tables, thus creating work stations. Double-sided, open or closed with drawers and doors, these furniture units easily furnish the centre of a room and its walls. The same flexibility can be found with finishes and colours that enhance monochrome rigour or add contrasting effects with the different shades of seating and cushions.



# ADD S

Francesco Rota | 2016

Modular system of storage and seating with aluminium frame and legs. Storage units in powder coated metal with shelves, drawers, doors and backs in several finishes. Table tops in white Hpl Fenix®. Seating with elastic support, cushions in molded fire retardant foam with polyester fiber and removable fabric, leather or eco-leather. Also available a drawer unit on castors with lock. ADD System can be combined with the ADD table system and ADD seating system.

## legs



## frame

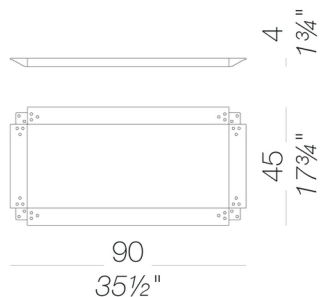

## top for small table

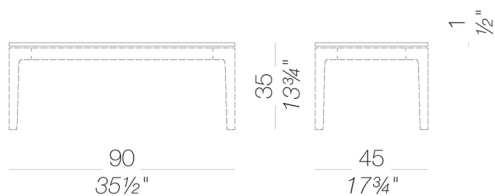

## cabinets

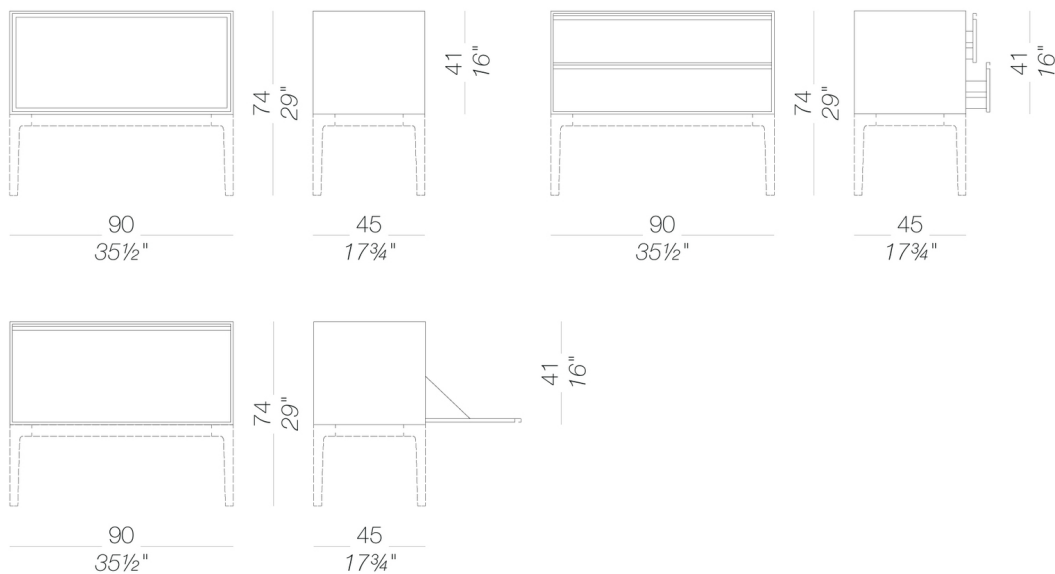

# ADD S

Francesco Rota | 2016

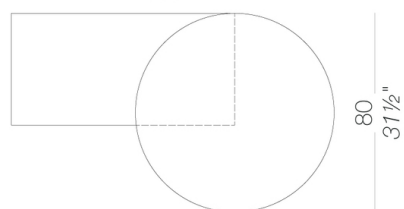
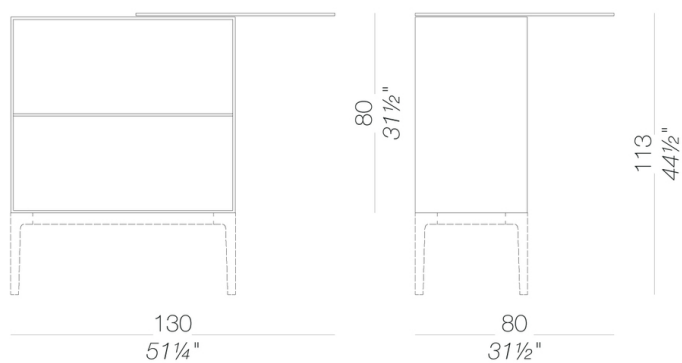
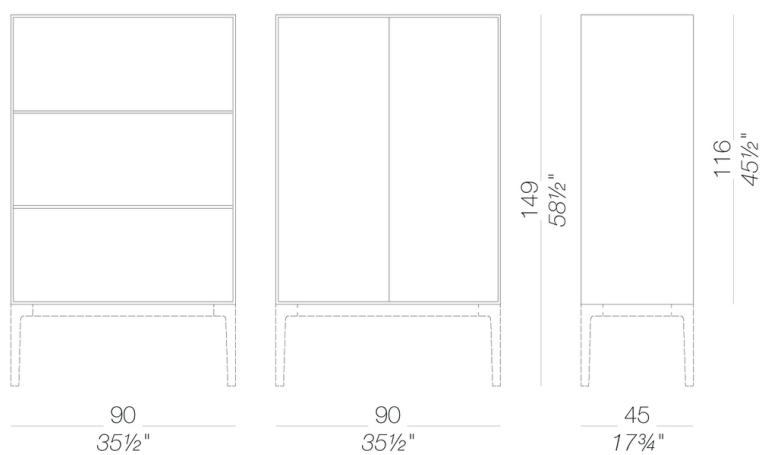
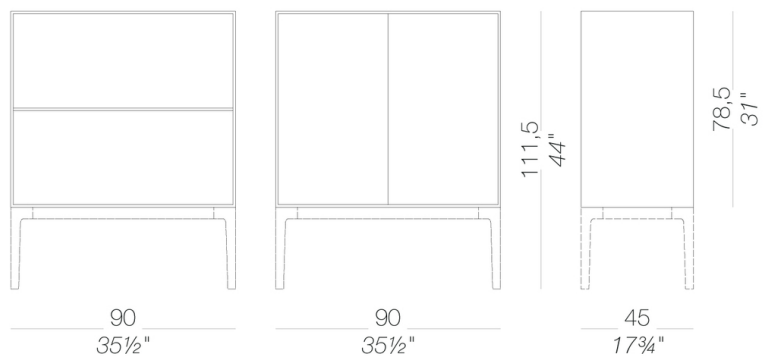

# ADD S

Francesco Rota | 2016

## frame for seat

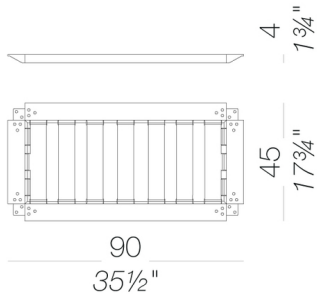

## cushion

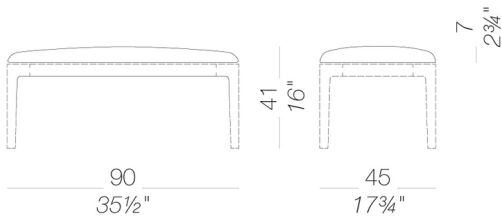

## drawer unit on castors

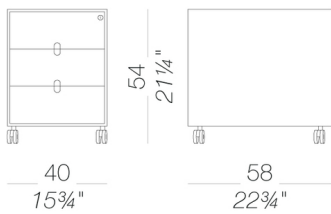

# ADD S

Francesco Rota | 2016

## frame



powder coating  
white  
1 Colors

## drawer unit on castors



powder coating  
black  
1 Colors

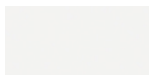

powder coating  
white  
1 Colors

## upholstery for drawers and doors



wood  
blanch oak  
1 Colors

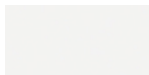

lacquered  
lacquered  
2 Colors



fabric  
Hallingdal 65  
47 Colors



fabric  
Canvas 2  
40 Colors



fabric  
Steelcut Trio 3  
48 Colors



fabric  
Remix 2  
24 Colors



fabric  
Clara 2  
24 Colors



fabric  
Fiord  
24 Colors



fabric  
Divina MD  
24 Colors



fabric  
Divina Melange 2  
24 Colors



fabric  
Tonica 2  
39 Colors



fabric  
Medley  
37 Colors



fabric  
Swing  
24 Colors

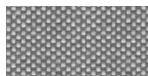

fabric  
Maya  
43 Colors



fabric  
Jet  
44 Colors



fabric  
Laser J Flash  
24 Colors



ecoleather  
GRIMM FR  
24 Colors

## backs

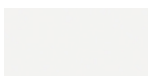

powder coating  
white  
1 Colors



wood  
blanch oak  
1 Colors

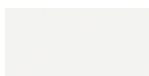

lacquered  
lacquered  
2 Colors



metal  
perforated metal  
2 Colors



fabric  
Hallingdal 65  
47 Colors



fabric  
Canvas 2  
40 Colors



fabric  
Steelcut Trio 3  
48 Colors



fabric  
Remix 2  
24 Colors



fabric  
Clara 2  
24 Colors



fabric  
Fiord  
24 Colors

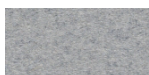

fabric  
Divina MD  
24 Colors



fabric  
Divina Melange 2  
24 Colors

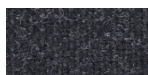

fabric  
Tonica 2  
39 Colors



fabric  
Medley  
37 Colors



fabric  
Swing  
24 Colors

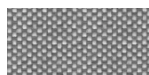

fabric  
Maya  
43 Colors



fabric  
Jet  
44 Colors



fabric  
Laser J Flash  
24 Colors



ecoleather  
GRIMM FR  
24 Colors

## cushion



fabric  
Hallingdal 65  
47 Colors

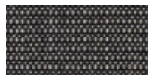

fabric  
Canvas 2  
40 Colors



fabric  
Steelcut Trio 3  
48 Colors



fabric  
Remix 2  
24 Colors



fabric  
Clara 2  
24 Colors



fabric  
Fiord  
24 Colors



fabric  
Divina MD  
24 Colors



fabric  
Divina Melange 2  
24 Colors



fabric  
Tonica 2  
39 Colors



fabric  
Medley  
37 Colors



fabric  
Swing  
24 Colors

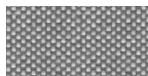

fabric  
Maya  
43 Colors



fabric  
Jet  
44 Colors



fabric  
Laser J Flash  
24 Colors



ecoleather  
GRIMM FR  
24 Colors

# ADD S

Francesco Rota | 2016

## top



HPL 10 mm  
HPL fenix  
2 Colors

**consult the portfolio for the range of colors, fabrics, eco-leather, soft-leather.**

### use and maintenance instructions

Clean all parts in wood, leather, fabric and metal with a damp cloth or a diluted neutral cleaner. Do not use cleaners with alcohol, bleach, solvent or abrasive products. Any liquid spilt on the product must be wiped up immediately. When lifting or moving the product, hold it on the structure and not under the seat. The product should not be subjected to unbalanced weights, as it is designed for a proper rest on the foothold (on four legs or on the base). Our company relieves from any responsibility in case of damage caused to fragile floors. Avoid any improper use of the product: do not step on the product, on the footrest or on the armrests. Avoid any movements that could compromise the proper functionality of the product or the safety of the users. Wood and leather, being natural materials, could be easily damaged. Small impurities or imperfections are within quality standard range. Do not expose the product to weather conditions or atmospheric agents, nor to heat sources over 40°C. Also products for outdoor use could be afflicted by atmospheric agents. The product could undergo possible exterior changes due to particular exposure to heat, humidity and saltiness. An appropriate and frequent maintenance and cleaning of the product enhances its durability. The product could change colour and shade, if exposed to direct sunlight. Maintenance has to be carried out by experienced staff. Dispose of the package only after assembling the product, in order to avoid the loss of ironmongery and components. Once the product has been dismantled, the product itself or its components must be given to the public garbage disposal system, according to the legislation in force.