

# UNO S230

Francesco Rota | 2016



# UNO

Francesco Rota | 2016

It has such an original character that it transforms and happily remains the same. With its minimalist versatile design, the UNO chair is part of a system, intended for different roles and moments in the office and the home. The seat is the standard feature, whereas the backrest varies: high for the executive version for maximum back support, and lower for relaxing in any environment. Colours, materials and base supports provide countless options. What remains unmistakable is the simplicity of a great idea.



# UNO

Francesco Rota | 2016

## S230 Height-adjustable, on castors

UNO | S230 S231 S232 S233 S242 S243 S244 S245 S246 S247 S248 S253 S257 S258 S259 S260

Family of chairs with height adjustable or fixed base in die-cast aluminium, either sandblasted or powder coated, with castors and tilt mechanism. Seat and backrest in several heights are made of fire retardant polyurethane foam upholstered with fabric, leather or eco-leather. Tilt mechanism is highly suggested for lounge versions.

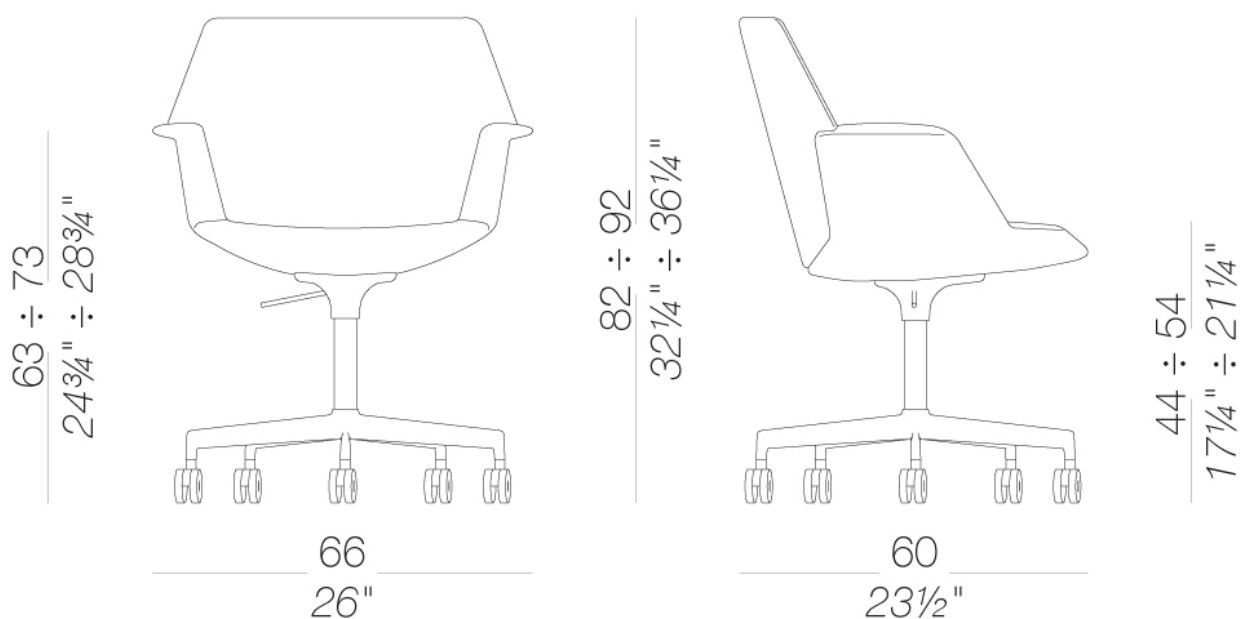

# UNO S230

Francesco Rota | 2016

## frame



powder coating  
black  
1 Colors

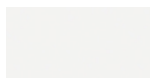

powder coating  
white  
1 Colors



metal  
aluminium  
1 Colors

## upholstery



fabric  
Hallingdal 65  
47 Colors



fabric  
Canvas 2  
40 Colors

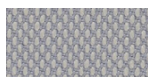

fabric  
Steelcut Trio 3  
48 Colors



fabric  
Clara 2  
24 Colors

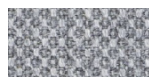

fabric  
Fiord  
24 Colors

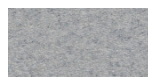

fabric  
Divina MD  
24 Colors



fabric  
Divina Melange 2  
24 Colors



fabric  
Tonica 2  
39 Colors



fabric  
Swing  
24 Colors

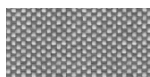

fabric  
Maya  
43 Colors



fabric  
Jet  
44 Colors



fabric  
Laser J Flash  
24 Colors

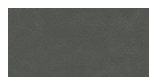

soft-leather  
soft-leather  
7 Colors



ecoleather  
GRIMM FR  
24 Colors

**consult the portfolio for the range of colors, fabrics, eco-leather, soft-leather.**

## use and maintenance instructions

Clean all parts in wood, leather, fabric and metal with a damp cloth or a diluted neutral cleaner. Do not use cleaners with alcohol, bleach, solvent or abrasive products. Any liquid spilt on the product must be wiped up immediately. When lifting or moving the product, hold it on the structure and not under the seat. The product should not be subjected to unbalanced weights, as it is designed for a proper rest on the foothold (on four legs or on the base). Our company relieves from any responsibility in case of damage caused to fragile floors. Avoid any improper use of the product: do not step on the product, on the footrest or on the armrests. Avoid any movements that could compromise the proper functionality of the product or the safety of the users. Wood and leather, being natural materials, could be easily damaged. Small impurities or imperfections are within quality standard range. Do not expose the product to weather conditions or atmospheric agents, nor to heat sources over 40°C. Also products for outdoor use could be afflicted by atmospheric agents. The product could undergo possible exterior changes due to particular exposure to heat, humidity and saltiness. An appropriate and frequent maintenance and cleaning of the product enhances its durability. The product could change colour and shade, if exposed to direct sunlight. Maintenance has to be carried out by experienced staff. Dispose of the package only after assembling the product, in order to avoid the loss of ironmongery and components. Once the product has been dismantled, the product itself or its components must be given to the public garbage disposal system, according to the legislation in force.