

AUKI S113 | Lounge chair

Hee Welling | 2015



There are moments during the day that go beyond a right angle and seek the sinuous embracing line that supports the body, protects and relaxes it. These are moments for the AUKI armchair. Like a shell, its curved shape gently opens up to create a subtle armrest. The headrest and stool complete its sheer comfort and transform the chair into an elegant chaise-longue. A wide choice of base supports, for the two different complementary small tables, square and round, enhance this perfectly versatile armchair.



AUKI

Hee Welling | 2015

S113 | Lounge chair star-shaped swivel base

AUKI | S112 S113 S115 S117 S118

Lounge chair with fire-retardant moulded polyurethane foam upholstered with fabric, soft leather or eco-leather. Four legged base in metal or ash, 4-star or round swivel base.

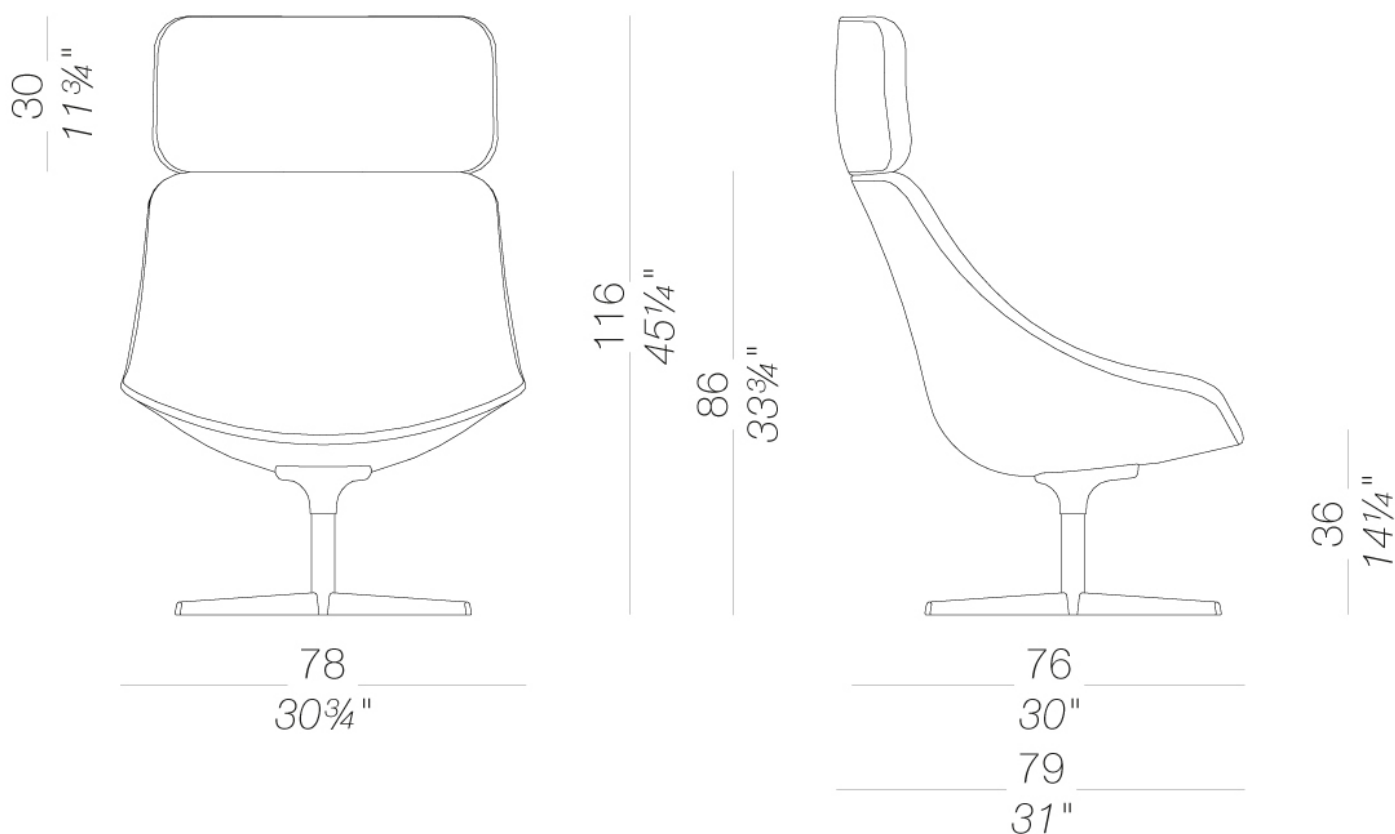

AUKI S113 | Lounge chair

Hee Welling | 2015

frame



powder coating
black
1 Colors

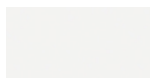

powder coating
white
1 Colors



metal
mat chromed
1 Colors

upholstery



fabric
Hallingdal 65
47 Colors



fabric
Canvas 2
40 Colors

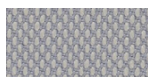

fabric
Steelcut Trio 3
48 Colors



fabric
Clara 2
24 Colors

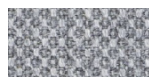

fabric
Fiord
24 Colors

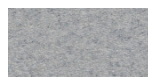

fabric
Divina MD
24 Colors



fabric
Divina Melange 2
24 Colors



fabric
Tonica 2
39 Colors



fabric
Swing
24 Colors

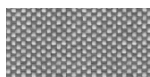

fabric
Maya
43 Colors



fabric
Jet
44 Colors



fabric
Laser J Flash
24 Colors

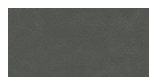

soft-leather
soft-leather
7 Colors



ecoleather
GRIMM FR
24 Colors

consult the portfolio for the range of colors, fabrics, eco-leather, soft-leather.

use and maintenance instructions

Clean all parts in wood, leather, fabric and metal with a damp cloth or a diluted neutral cleaner. Do not use cleaners with alcohol, bleach, solvent or abrasive products. Any liquid spilt on the product must be wiped up immediately. When lifting or moving the product, hold it on the structure and not under the seat. The product should not be subjected to unbalanced weights, as it is designed for a proper rest on the foothold (on four legs or on the base). Our company relieves from any responsibility in case of damage caused to fragile floors. Avoid any improper use of the product: do not step on the product, on the footrest or on the armrests. Avoid any movements that could compromise the proper functionality of the product or the safety of the users. Wood and leather, being natural materials, could be easily damaged. Small impurities or imperfections are within quality standard range. Do not expose the product to weather conditions or atmospheric agents, nor to heat sources over 40°C. Also products for outdoor use could be afflicted by atmospheric agents. The product could undergo possible exterior changes due to particular exposure to heat, humidity and saltiness. An appropriate and frequent maintenance and cleaning of the product enhances its durability. The product could change colour and shade, if exposed to direct sunlight. Maintenance has to be carried out by experienced staff. Dispose of the package only after assembling the product, in order to avoid the loss of ironmongery and components. Once the product has been dismantled, the product itself or its components must be given to the public garbage disposal system, according to the legislation in force.