

PASS S121

Hee Welling | 2012



PASS

Hee Welling | 2012

Like waves on a calm day, they rise, gently fall and extend as far as the sand, infinitely. PASS armchairs are inspired by these lines, expressing the continuous rhythm of the sea in their profile. The design is fluid and embracing. The wide base adds lightness and comfort to the seat. Pass is ideal for the office or the home, and for those waiting in an airport lounge, dreaming of departing.



PASS

Hee Welling | 2012

S121 Round swivel base

PASS | S119 S121 S130 S131 S134 S135 S136 S168

Upholstered chair with fire retardant moulded foam covered in fabric, soft leather or eco-leather, also in 2 colours of the same fabric. Available with sled base, swivel round base, die-cast aluminium swivel base, also on castors and height adjustable. Powder coated or sandblasted.

TEST 1 IM - Hallingdal, Maya

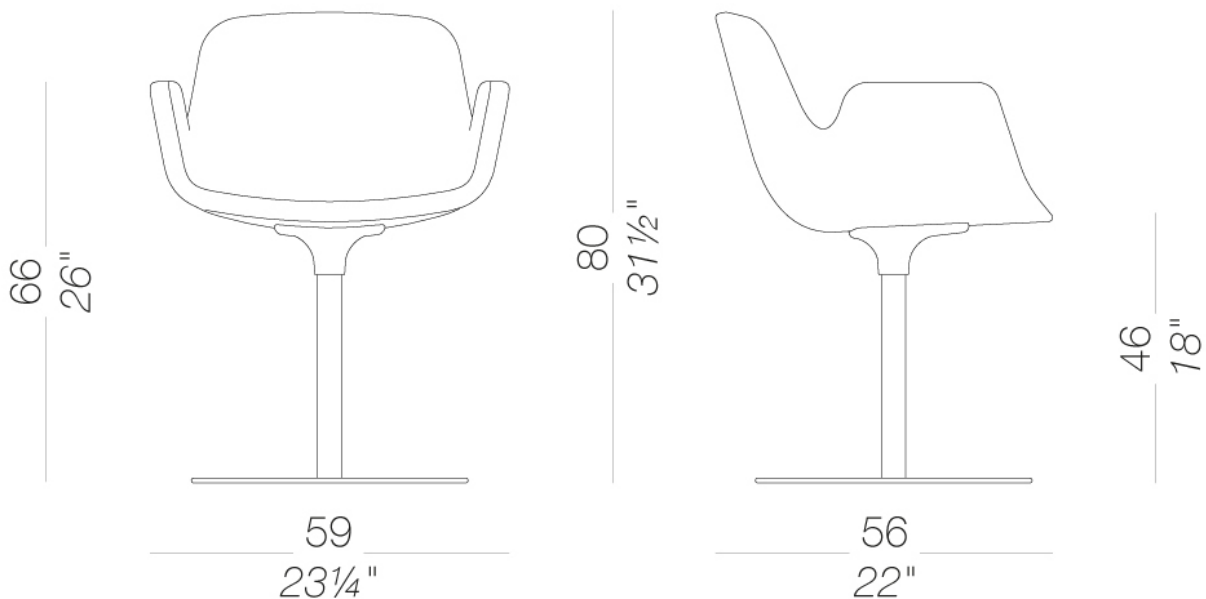

PASS S121

Hee Welling | 2012

frame



powder coating
black
1 Colors

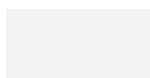

powder coating
white
1 Colors



metal
stainless steel
1 Colors

upholstery



fabric
Hallingdal 65
47 Colors



fabric
Canvas 2
40 Colors

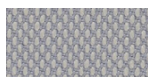

fabric
Steelcut Trio 3
48 Colors



fabric
Clara 2
24 Colors

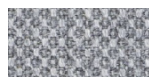

fabric
Fiord
24 Colors

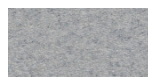

fabric
Divina MD
24 Colors



fabric
Divina Melange 2
24 Colors



fabric
Tonica 2
39 Colors



fabric
Swing
24 Colors

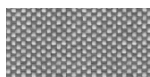

fabric
Maya
43 Colors



fabric
Jet
44 Colors



fabric
Laser J Flash
24 Colors

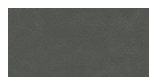

soft-leather
soft-leather
7 Colors



ecoleather
GRIMM FR
24 Colors

consult the portfolio for the range of colors, fabrics, eco-leather, soft-leather.

use and maintenance instructions

Clean all parts in wood, leather, fabric and metal with a damp cloth or a diluted neutral cleaner. Do not use cleaners with alcohol, bleach, solvent or abrasive products. Any liquid spilt on the product must be wiped up immediately. When lifting or moving the product, hold it on the structure and not under the seat. The product should not be subjected to unbalanced weights, as it is designed for a proper rest on the foothold (on four legs or on the base). Our company relieves from any responsibility in case of damage caused to fragile floors. Avoid any improper use of the product: do not step on the product, on the footrest or on the armrests. Avoid any movements that could compromise the proper functionality of the product or the safety of the users. Wood and leather, being natural materials, could be easily damaged. Small impurities or imperfections are within quality standard range. Do not expose the product to weather conditions or atmospheric agents, nor to heat sources over 40°C. Also products for outdoor use could be afflicted by atmospheric agents. The product could undergo possible exterior changes due to particular exposure to heat, humidity and saltiness. An appropriate and frequent maintenance and cleaning of the product enhances its durability. The product could change colour and shade, if exposed to direct sunlight. Maintenance has to be carried out by experienced staff. Dispose of the package only after assembling the product, in order to avoid the loss of ironmongery and components. Once the product has been dismantled, the product itself or its components must be given to the public garbage disposal system, according to the legislation in force.