

KIPU D03 | Large pouf

Anderssen & Voll | 2014



KIPU

Anderssen & Voll | 2014

In summer, it was a pleasure to collect the pebbles on the beach, hold them in your hand and feel their edges smoothed by the waves. And some of them would end up in your pocket as a reminder of an encounter, a unique day. Anderssen & Voll have retraced these happy moments and transformed the most beautiful pebbles into a wonderful collection of poufs. All in different heights, colours and shapes. All in versatile combinations that transform a top into a seat. And it is as if every office, lounge and home environment suddenly overlooked a beach on the North Sea.



KIPU

Anderssen & Voll | 2014

D03 | Large pouf 130x130 H36

Ottoman with fire-retardant moulded polyurethane foam and polyester fiber with removable fabric, soft leather or eco-leather. Feet in polyethylene with felt.

TEST 1 IM - Hallingdal 65, GRIMM FR

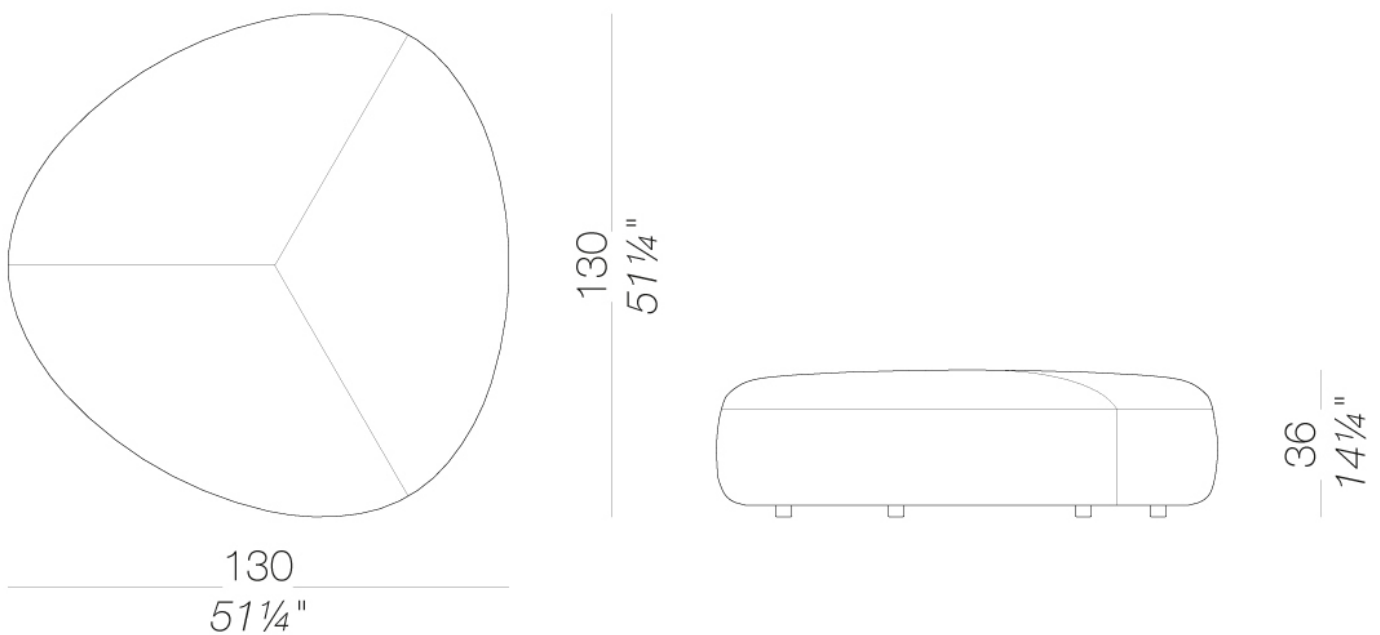

KIPU D03 | Large pouf

Anderssen & Voll | 2014

upholstery

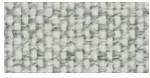

fabric
Hallingdal 65
47 Colors



fabric
Canvas 2
40 Colors



fabric
Steelcut Trio 3
48 Colors

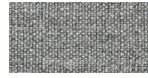

fabric
Remix 2
24 Colors

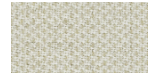

fabric
Clara 2
24 Colors



fabric
Fiord
24 Colors



fabric
Divina MD
24 Colors



fabric
Divina Melange 2
24 Colors



fabric
Tonica 2
39 Colors



fabric
Medley
37 Colors



fabric
Swing
24 Colors

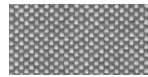

fabric
Maya
43 Colors



fabric
Jet
44 Colors



fabric
Laser J Flash
24 Colors



soft-leather
soft-leather
7 Colors



ecoleather
GRIMM FR
24 Colors

consult the portfolio for the range of colors, fabrics, eco-leather, soft-leather.

use and maintenance instructions

Clean all parts in wood, leather, fabric and metal with a damp cloth or a diluted neutral cleaner. Do not use cleaners with alcohol, bleach, solvent or abrasive products. Any liquid spilt on the product must be wiped up immediately. When lifting or moving the product, hold it on the structure and not under the seat. The product should not be subjected to unbalanced weights, as it is designed for a proper rest on the foothold (on four legs or on the base). Our company relieves from any responsibility in case of damage caused to fragile floors. Avoid any improper use of the product: do not step on the product, on the footrest or on the armrests. Avoid any movements that could compromise the proper functionality of the product or the safety of the users. Wood and leather, being natural materials, could be easily damaged. Small impurities or imperfections are within quality standard range. Do not expose the product to weather conditions or atmospheric agents, nor to heat sources over 40°C. Also products for outdoor use could be afflicted by atmospheric agents. The product could undergo possible exterior changes due to particular exposure to heat, humidity and saltiness. An appropriate and frequent maintenance and cleaning of the product enhances its durability. The product could change colour and shade, if exposed to direct sunlight. Maintenance has to be carried out by experienced staff. Dispose of the package only after assembling the product, in order to avoid the loss of ironmongery and components. Once the product has been dismantled, the product itself or its components must be given to the public garbage disposal system, according to the legislation in force.