



# Maarten Table

BY VÍCTOR CARRASCO

# Maarten Table

BY VÍCTOR CARRASCO

Technical Info EN

2014



Table system is based on a technical minimalist leg solution that does not need a structure and can be attached directly to the table top.

Having no structure and a table top thickness of just 5 mm it acquires great visual lightness. There are endless uses, finishes and formats with this innovative system.

Its "one mile" concept expresses how it can be used for breakfast in the kitchen, then working in the office, for eating in its restaurant version and later on for a meeting around it as a boardroom table and finally for dinner in the evening.

## Víctor Carrasco

Born in Valencia (Spain) in 1974, Víctor Carrasco began his professional career after graduating Cum Laude in Industrial Design Engineering at the Polytechnic University of Valencia.

Shying away from trends and fads, he has developed and positioned international brands with remarkable added value, thanks to his passion for synthesis, sustainable growth and his pragmatic vision of the future.

Since 2007, he has been combining his position as strategic director of Viccarbe with that of Director Business Development for the prestigious American multinational Coalesse (Steelcase Inc.). Likewise, as an industrial designer, he has collaborated with numerous international companies.

He was the recipient of the Prince Felipe Award for Business Excellence and he has also won the German Design Award.



HEIGHT 74 | 29<sup>13</sup>/<sub>64</sub>

**MAA80\_**  
table 80x80 | 31<sup>1</sup>/<sub>2</sub> x 31<sup>1</sup>/<sub>2</sub>

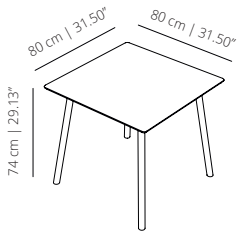

**MAA160\_**  
table 160x80 | 31<sup>1</sup>/<sub>2</sub> x 62<sup>63</sup>/<sub>64</sub>

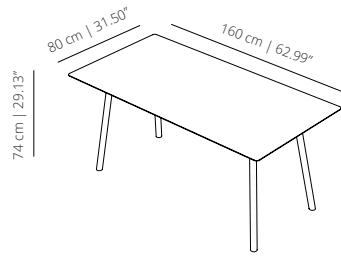

HEIGHT 74 | 29<sup>13</sup>/<sub>64</sub>

**MAA160\_**  
table 160x90 | 35<sup>7</sup>/<sub>16</sub> x 62<sup>63</sup>/<sub>64</sub>

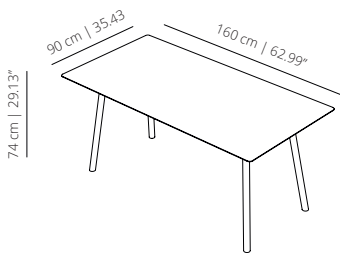

**MAA180\_**  
table 180x80 | 70<sup>55</sup>/<sub>64</sub> x 31<sup>1</sup>/<sub>2</sub>

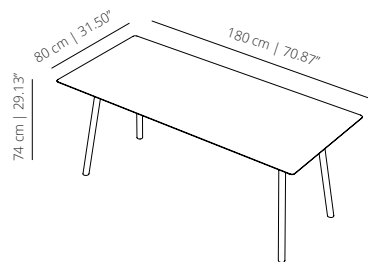

HEIGHT 74 | 29<sup>13</sup>/<sub>64</sub>

**MAA180\_**  
table 180x90 | 35<sup>7</sup>/<sub>16</sub> x 62<sup>63</sup>/<sub>64</sub>

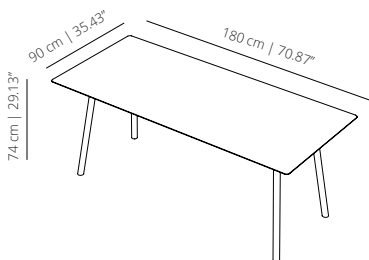

**MAA200\_**  
table 200x80 | 31<sup>1</sup>/<sub>2</sub> x 78<sup>47</sup>/<sub>64</sub>

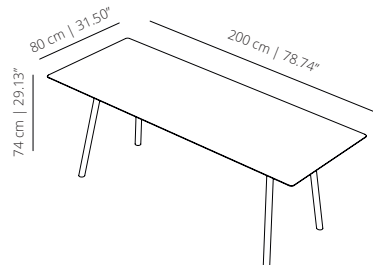

HEIGHT 74 | 29<sup>13</sup>/<sub>64</sub>

**MAA200\_**  
table 200x80 | 35<sup>7</sup>/<sub>16</sub> x 78<sup>47</sup>/<sub>64</sub>

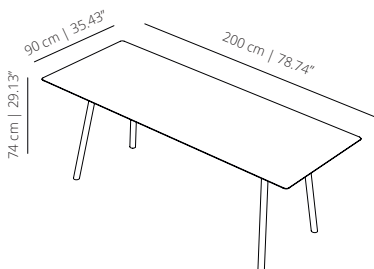

**MAAD120\_**  
table 120 | 47<sup>1</sup>/<sub>4</sub>

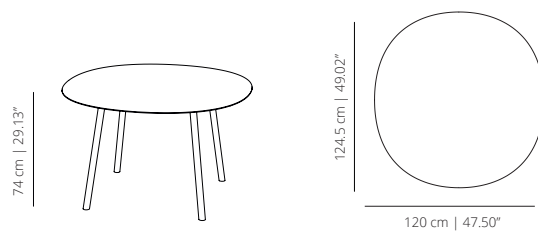

HEIGHT 74 | 29<sup>5</sup>/<sub>16</sub>"

**MAAD160\_**  
table 160 | 62<sup>63</sup>/<sub>64</sub>"

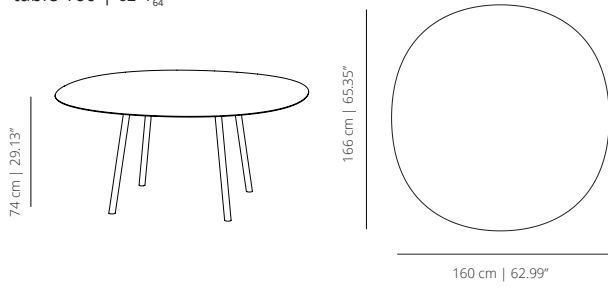

**MAAA180\_**  
table 180x80 | 70<sup>55</sup>/<sub>64</sub>" x 31<sup>1</sup>/<sub>2</sub>" return table

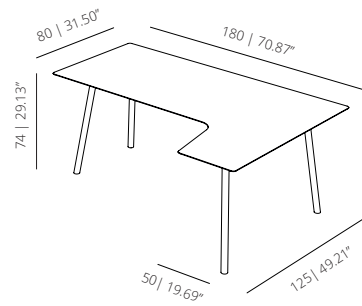

## ACCESSORIES

**CARB**  
storage unit 2 drawers + filling cabinet

For folders, larger than DIN-4, some accessories are required. Not included.

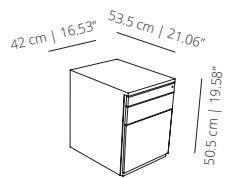

**CAJB**  
storage unit 4 drawer

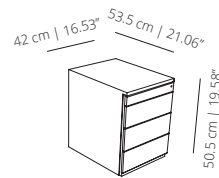

## ACCESSORIES

---

### AC03B wire hole

Cut out of the board is included.  
Dimensions: Ø 6 cm | 2.36"

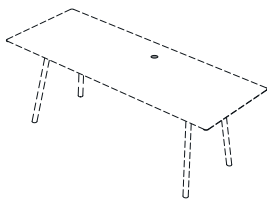

### TRMEC cut out

Table top with incision to measure. The price is indicated per table top.

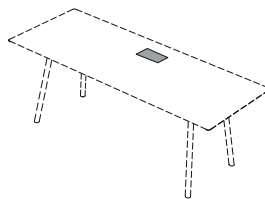

### TRPROT table top protector in eco leather

Dimension: 44x90 cm | 17.3"x35.4"

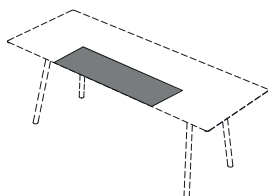

### LECAN wire holder

Dimension: 99x16x9 cm | 38.97"x6.29"x 3.54"



### LEWIRES simple wire column

Dimension: 25x12x71cm | 9.8"x4.7"x27.9"



### LEWIRED double wire column

Dimension: 25x12x71cm | 9.8"x4.7"x27.9"

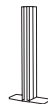

### MAAF160\_ modesty screen 160

Dimensions: 114x33 cm | 44.6"x12.7"

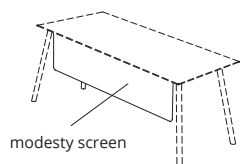

### MAAF180\_ modesty screen 180 and 200

Dimensions: 134x33 cm | 52.6"x12.7"

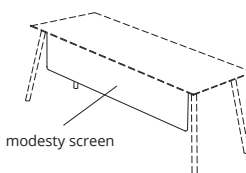

## ACCESSORIES

---

For the different table tops, we offer the possibility of installing the following accessories. The drawings with the location of the accessories need the approval of the technical department.

### CAP\*

rectangular conduit

Metallic access cover to the lower part of the table. Available in white, black or grey. Does not include electrifications. Dimensions: 32x15 cm | 12.59"x5.90"



*\*Cut out not included*

---

### CAPP\*

rectangular conduit plus

Metal access cover to the lower part of the table, for wooden table tops. Metal frame available in black or grey and central part in the veneer of the finish of the table. Does not include electrifications. Dimensions: 32x15 cm | 12.59"x5.90"



*\*Cut out not included*

---

### MAAUSB

USB port

USB port for charging electronic devices totally integrated in the bench. Available in white or black. Dimensions: Ø 3 cm | 1.18"



### MAAWI

wireless charger

Concealed wireless charger that is compatible with all devices with Qi version 1.2 wireless charging system. It has a quick charge system.

*NOTE: The wire hole is included if it coincides with the center of the base column. It is not included for other positions.*



### BOX-E\* | BOX-M\*

power box for table top

BOX-E: 4 plugs | BOX-M: 4 elements (plugs and multimedia) elements. Available in white, black or grey. Dimensions: 32x15 cm | 12.59"x5.90".

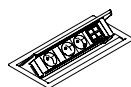

*\*Cut out not included*

---

### BOXP-E\* | BOXP-M\*

power box plus for table top

BOXP-E: 4 plugs | BOXP-M: 4 elements (plugs and multimedia). Metal cover with 4 plugs or combined with integrated multimedia elements, for wooden table tops. Metal frame available in black or grey and central part in the veneer of the finish of the table. Dimensions: 32x15 cm | 12.59"x5.90".

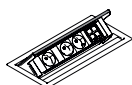

*\*Cut out not included*

---

### CUBO

table top protector in eco leather

Power box available with 2 plugs or combined with integrated multimedia elements. Metal frame available in white or black.



*NOTE: Not available for compact.*

---

**Legs adjustable in height:**

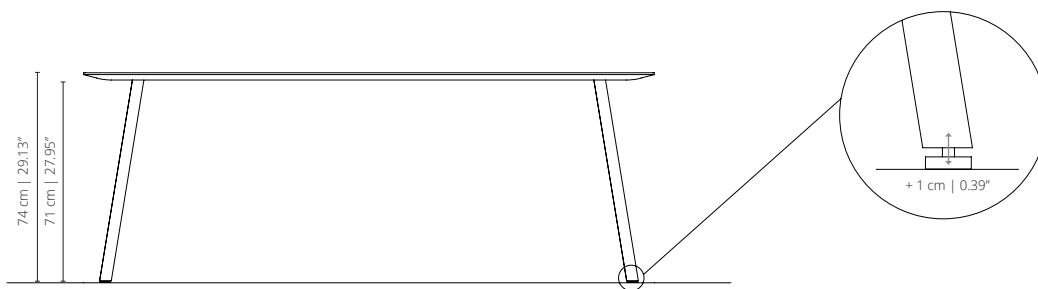

**Thickness and type of table top edge:**

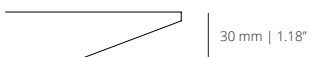

## FINISHES

### LEGS

#### Powder coated



white  
RAL 9003



black  
RAL 9005



altea blue  
RAL 5000



sand  
RAL 1019



fluor orange  
NCS 3005Y50R

#### Stained



matt oak



cognac



wenge



ash

### TABLE TOP

#### Lacquered



white  
RAL 9003



black  
RAL 9005



blue  
RAL 5024



tobacco  
RAL 8028



smoke  
RAL 1019



grey  
RAL 7004



red  
RAL 9001



silver  
RAL 9006



mustard  
RAL 1012



green  
RAL 6007



bronze



sand  
NCS 3005Y50R

#### Stained



matt oak



cognac



wenge



ash

#### HPL with MDF



black



white

## TECHNICAL INFO

Maarten is a collection of tables and complements that allows many compositions and finishes.

The 30 mm thick cover or work surface is made with microtextured MDF. It is lacquered with one of our collection's finishes, making it very scratch resistant. It also comes with a solid oak veneer, stained in mate, wenge, cognac or ash. Available in high resistance materials such as HPL with MDF for heavy contract use.

The legs are made from calibrated steel, powder coated in thermoreinforced polyester. Available in white, black, fluorescent orange, altea blue or a stained oak veneer with the finishes of our collection.

*NOTE: Due to the fact that the wood used is natural, the finish may vary.*

## CERTIFICATIONS

UNE EN 527-1:11, UNE EN 527-2-3:03 and ANSI/BIFMA X5.5:2014 (table height 74).



